



T-2000

A self-contained source collector designed to capture fume generated from moderate-to-heavy welding applications.

- Designed to handle one or two welding stations using Ex-Arms
- Ceiling-mount configuration saves valuable plant floor space and provides optimum range of the Ex-Arms
- FLUENT®* designed inlet and dust hopper minimizes fume re-entrainment and reduce maintenance expense
- Automatic pulse-cleaning system for continuous welding operations
- Proprietary filter cleaning system lengthens filter life
- Ultra-Web® FR filter cartridges featuring nanofiber technology provide high filtration efficiency and long filter life
- MERV** 13 filtration efficiency rating per ASHRAE 52.2-2007
- Recirculation of clean air reduces need for costly make-up air

* FLUENT is a registered trademark of Fluent, Inc.

** The Minimum Efficiency Reporting Value (MERV) of this filter cartridge has been determined through independent laboratory testing using ASHRAE 52.2 (2007) test standards. The MERV rating was determined at a face velocity of 118 feet per minute (36.0 meters per minute) and loading up to four inches (101.6 mm) water gauge. Actual efficiency of any filter cartridge will vary according to the specific application parameters. Dust concentration, airflow, particle characteristics, and pulse cleaning methods all affect filtration efficiency.

DIMENSIONS & SPECIFICATIONS

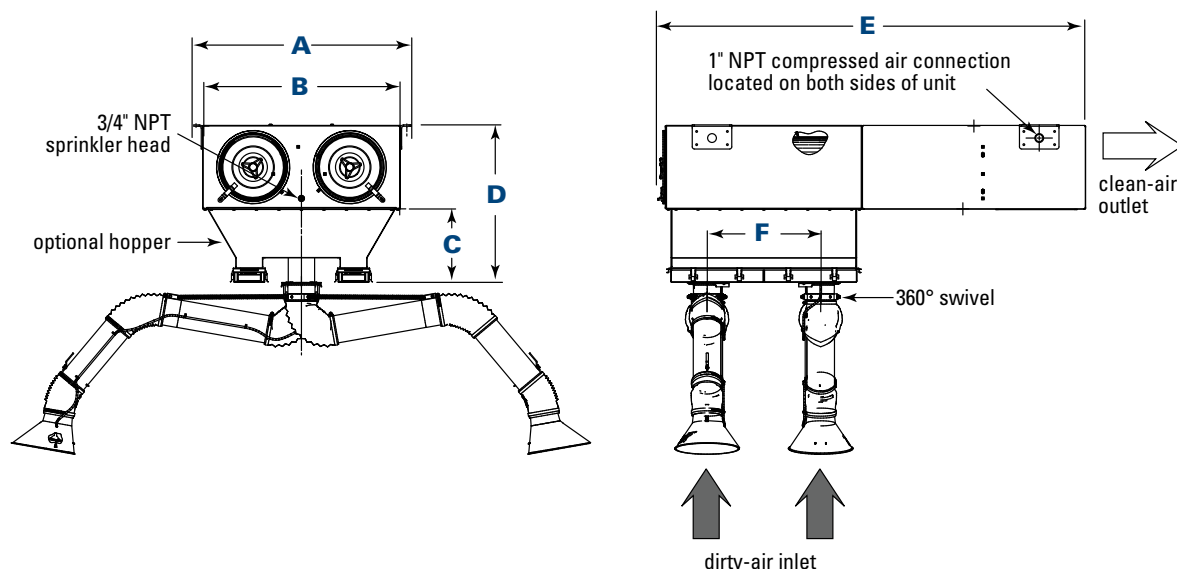

Model	Nominal Airflow*		No. of Filters (Ultra-Web FR)	Filter Area		No. of 3/4" Valves	Dimensions								Shipping Weight		Sound Level dB(A)†					
	cfm	m³/h		ft²	m²		A		B		C		D		E		F		lb	kg	Fan	Pulse
							in	mm	in	mm	in	mm	in	mm	in	mm	in	mm				
T-2000	890	1512	4	636	59.1	2	50.0	1270.0	45.0	1143.0	16.9	429.3	35.9	911.9	97.4	2474.0	25.9	657.9	790	358.3	71	80.5

STANDARD FEATURES & AVAILABLE OPTIONS

STANDARD	OPTIONAL
Ultra-Web® FR cartridges	Ex-Arm - 6.5 ft (2 m), 10 ft (3.0 m), 13 ft (4.0 m)
5 hp TEFC motor	Magnehelic®** gauge
One (1) Ex-Arm with light	Photohelic®** gauge
Sprinkler head	Hopper with re-entrainment baffles and four removal dust pans
110 VAC control box 208/230/460/60/3 voltage	Solenoid valve silencer
10-year warranty	

* Based on clean filters, per Ex-Arm.

** Magnehelic and Photohelic are registered trademarks of Dwyer Instruments, Inc.

† db(A) sound levels are an average of measurements made in a laboratory environment. Installed sound levels will vary depending on the measurement location, operating conditions, and installation.

Significantly improve the performance of your collector with genuine Donaldson Torit replacement filters and parts. **Call Donaldson Torit today 800-365-1331.**



Tel 800-365-1331 (USA)
Tel 800-343-3639 (within Mexico)

donaldsontorit@donaldson.com
donaldsontorit.com

Donaldson Company, Inc.
Torit
P.O. Box 1299
Minneapolis, MN
55440-1299 U.S.A.

EXACTLY WHAT YOU NEED.™

Trunk 2000 Fume Collector (11/12)
© 1999 Donaldson Co., Inc. All Rights Reserved. All products, product specifications, and data (airflow, capacity, dimensions, or availability) are subject to change without notice, and may vary by region or country.