

Dryflo® mist collectors from Donaldson® Torit® are effective and efficient mist filtration solutions, providing a more productive work environment by reducing coolant and machining oil mists in a machine-mountable package. The Dryflo® provides high performance technology and easy, predictable maintenance.

- High performance three-stage filtration improves collection efficiency at every stage
- Provides a cleaner work environment for maximum productivity
- Reduces risk of mist related hazards
- Quick and easy filter changes—workers have minimal contact with collected oil
- Predictable maintenance with a differential pressure gauge
- Lower plant maintenance costs
- Mounts directly onto a machining center to collect oil, water-soluble, semi-synthetic and synthetic coolant
- Low profile
- 10-year warranty
- Helps support OSHA Clean Air Standards



Dryflo
Model DMC-MMA



Easy filter changeout

NORMAL OPERATION FOR DMC-MMA, -MMB

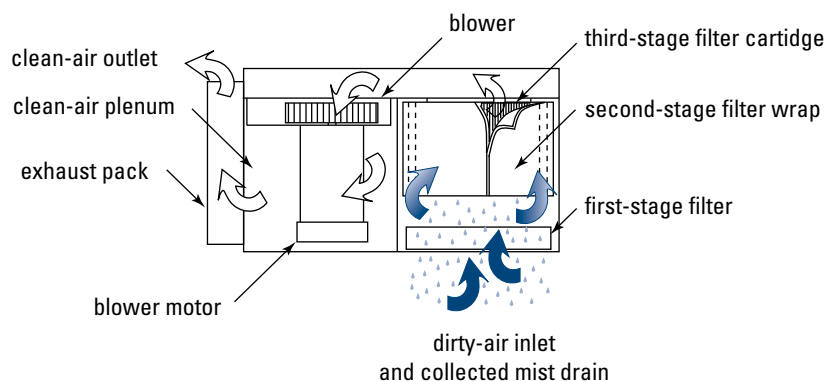

DRYFLO FILTER MEDIA

Dryflo® filter media is made from proprietary synthetic media incorporating both small and large fibers for optimum filtration. The smaller fibers provide increased filtration efficiency; after mist is captured and coalesced, the larger fibers allow the oil to drain from the filter. The media also incorporates a proprietary corrugation method which maintains uniform airflow and lower pressure while the media is saturated with oil.

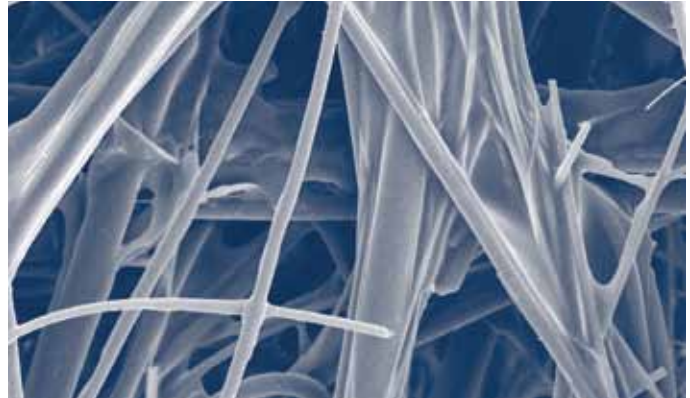

Dryflo Filter Media

HIGH PERFORMANCE THREE-STAGE FILTRATION: IMPROVES COLLECTION EFFICIENCY AT EVERY STAGE

FIRST-STAGE

A prefilter that removes larger mist droplets, metal dust and swarf captured by the collector. Wire mesh thin screen and polypropylene mesh are available.

SECOND STAGE

A three-layer wrap of synthetic high-loft material collects small mist drops into larger oil droplets, which drain out of the mist collector.

THIRD-STAGE

Collects, coalesces and drains the finer mist droplets generated by metalworking applications. Along with vertically oriented pleats, the third-stage filter cartridge incorporates the Pleatloc™ media spacing system, which enhances drainage and provides a lower pressure drop, higher filtration efficiency and less re-entrainment of collected mist.

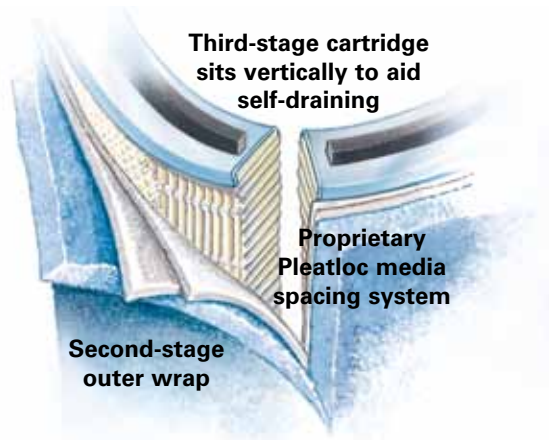
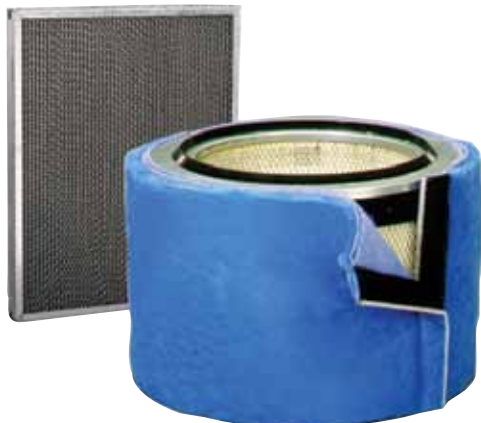

LONG-LASTING EFFICIENCY

The Dryflo® cartridge is a proven, highly efficient mist filter that actually increases efficiency over time when collecting soluble oil or synthetic fluid. In tests conducted by the University of North Carolina (UNC), the Dryflo was shown to offer increased efficiency over time, resulting in longer HEPA filter life and reduced HEPA filter replacement costs.

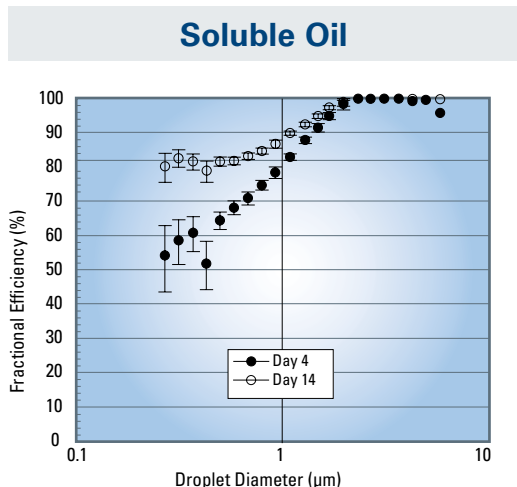

Efficiency vs. droplet diameter for Dryflo® cartridge and wrap assembly on days 4 and 14 with soluble oil at an airflow of 1000 cfm (28.3 m³/m). Error bars represent 95% confidence intervals.

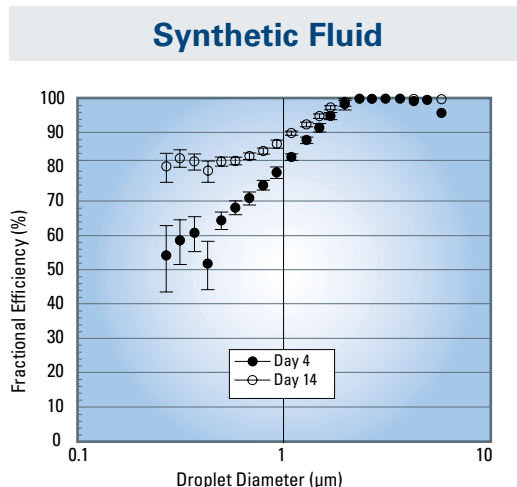

Efficiency vs. droplet diameter for Dryflo® cartridge and wrap assembly on days 4 and 14 with synthetic fluid at an airflow of 1000 cfm (28.3 m³/m). Error bars represent 95% confidence intervals.

GAUGING EFFICIENCY

Using UNC’s protocol for evaluating the cartridge efficiency, Dryflo® mist collectors with HEPA final filter are a reliable, high performance filtration solution. To prolong HEPA filter life, the upstream filter stages must also be highly efficient. HEPA life depends on the cumulative loading it receives, which in turn, depends on the performance of the upstream collection stages.

Evaluating efficiency as a function of droplet diameter and pressure drop over 14 days, UNC protocol determines the size distribution of droplets generated during a variety of wet machining operations. Droplet sizes ranging from 1.8 micron to 3.2 micron were tested to determine the average efficiency of Dryflo® collectors on soluble oil and synthetic fluid.

| Average Efficiency of Dryflo® on Soluble Oil and Synthetic Fluid | | |
|--|-----------------------------|--------------------------------|
| Droplet Size | Dryflo® Collector with HEPA | Dryflo® Collector without HEPA |
| 1.8 micron | 100% | 98% |
| 3.2 micron | 100% | 100% |

Note: The data provided in this report is a result of tests performed using the UNC protocol. When comparing these results with other products, be sure the data being compared is derived by the same methodology.

DIMENSIONS & SPECIFICATIONS

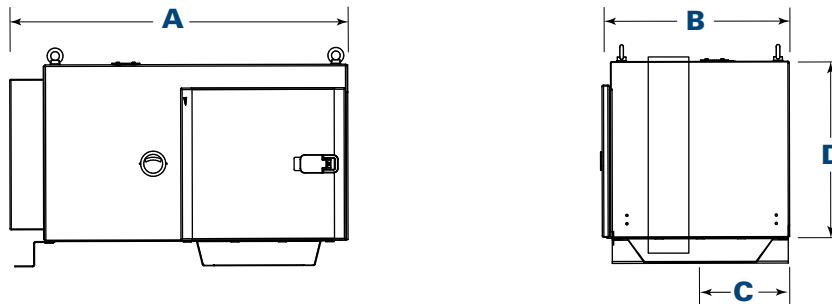

| Models | Nominal Airflow | | No. of Filters | Filter Area | | Motor (hp) | Shipping Weight | | Dimensions | | | | | | | | Sound Level db(A) |
|---------|-----------------|------|----------------|-------------|------|------------|-----------------|------|------------|-------|------|-------|------|-------|------|-------|-------------------|
| | cfm | m³/h | | ft² | m² | | lb | kg | A | | B | | C | | D | | |
| | | | | | | | | | in | mm | in | mm | in | mm | in | mm | |
| DMC-MMA | 390 | 662 | 1 | 41 | 12.5 | 0.75 | 85 | 38.6 | 30.3 | 769.6 | 16.0 | 406.4 | 8.0 | 203.2 | 15.8 | 401.3 | 65 |
| DMC-MMB | 800 | 1359 | 1 | 82 | 25.0 | 1.5 | 165 | 74.8 | 39.1 | 993.1 | 20.7 | 525.8 | 10.4 | 264.2 | 20.8 | 528.3 | 69 |

STANDARD FEATURES & AVAILABLE OPTIONS

| COLLECTOR DESIGN | Std | Opt |
|---------------------------------------|-----|-----|
| Mild Steel Construction | X | |
| Inlet Gasket | | X |
| Inlet Collar | | X |
| Inlet Hopper with Legs | | X |
| Inlet Hopper with Vibration Isolators | | X |
| Inlet Hopper with Flex-Duct | | X |
| Inlet Hopper with Impact Separator | | X |
| Machine Mount | X | |
| Ceiling Mount | | X |
| Collector Stand or Cart | | X |
| Junction Box | | X |
| Drain Collection Container | | X |
| CARTRIDGE FILTERS | | |
| First-Stage Wire Mesh | X | |
| Variety of Other Prefilters | | X |
| High Efficiency First-Stage | | X |

*Minihelic is a registered trademark of Dwyer Instruments, Inc.

| CARTRIDGE FILTERS (cont'd) | Std | Opt |
|---|-----|-----|
| Dryflo® Cartridge Filter with Wrap | X | |
| Fourth-Stage HEPA Filter | | X |
| Fourth-Stage 95% DOP Filter | | X |
| PAINT SYSTEM | | |
| Prime Coated Interior | X | |
| Textured Multi-Coat Paint Finish with 2,000-Hour Salt Spray Performance | X | |
| Premium Duty Finish | | X |
| Custom Colors, Materials, and Finishes | | X |
| ELECTRICAL CONTROLS, GAUGES AND ENCLOSURES | | |
| Minihelic®* Pressure Gauge | X | |
| Manual Motor Starter | | X |
| Type 12 (NEMA & UL) Motor Starter | | X |
| Remote Start/Stop | | X |
| Machine Tool Interlock | | X |
| Mounted and Prewired Motor Starters | | X |
| WARRANTY | | |
| 10-Year Warranty | X | |

Significantly improve the performance of your collector with genuine Donaldson Torit replacement filters and parts. **Call Donaldson Torit today 800-365-1331.**



Tel 800-365-1331 (USA)
Tel 800-343-3639 (within Mexico)

donaldsontorit@donaldson.com
donaldsontorit.com

Donaldson Company, Inc.
Torit
P.O. Box 1299
Minneapolis, MN
55440-1299 U.S.A.

EXACTLY WHAT YOU NEED.™

Dryflo Mist Collectors – DMC-MMA & DMC-MMB (11/12)
© 2010 Donaldson Co., Inc. All Rights Reserved. All products, product specifications, and data (airflow, capacity, dimensions, or availability) are subject to change without notice, and may vary by region or country. Donaldson Torit and Dryflo are registered trademarks of Donaldson Company, Inc. Contains Donaldson proprietary technology.